

Temperature Controller VTR-2

Application / Specified usage

- The temperature controller VTR-2 is used in conjunction with the temperature sensor Pt100 or Pt1000 to easily control and monitor temperatures.

Features

- Menu guidance using LC display
- Settable operating point, hysteresis and operating delay
- Switching function "min" / "max" can be toggled
- Can be connected to PT100 or PT1000
- 3 or 4-wire-technology
- Analog output: 0...10 V or 0/4...20 mA (optional)
- Sensor monitoring
- Display of the actual value in either °C or °F, as selected
- Connection via pluggable terminal blocks
- Narrow design (22.5mm)
- Universal power supply 24/20...255 V AC/DC

Authorizations



Temp. Controller VTR-2



Specification

Housing	acc. to DIN norm dimensions (W x H x D) protection class electrical connection	made of ABS for rail mounting acc. to EN 50022 22,5 x 111 x 120 mm IP 20 2,5 mm ² screw-type terminals pluggable
Ambient	operation temperature storage temperature humidity	0...+55 °C -10...+55 °C 0...95 % no condensation
Input		Pt100 / Pt1000 3- or 4-wire
Sensor current		500 µA
Wire compensation		max 100 Ω
Output	analog with option VTR-2 / A switching contact	current 0/4...20 mA (burden ≤ 500 Ω) voltage 0...10 V (load ≥ 1 kΩ) change-over contact for error message, max 250 V / 3 A AC
Accuracy		≤ ±0,1 % from measurement range
Temperature drift	typical	≤ 0,01 %/K
Display resolution		0,1 °C / °F
Step response 0...99 %		< 250 ms
Delay		0,1...5 s, step size 1 s
Hysteresis		1...40°, step size 1°
Switching point		-200...+850 °C / -328...+1562 °F, step size 1°
Lowest span	at option VTR-2 / A	50 °C / 122 °F
Switching function	adjustable	normal / inverting
Supply	AC / DC power consumption	24...255 V, 48...62 Hz / 20...255 V 2,5 W / 4,5 VA
Weight		148 g

Side- and front view

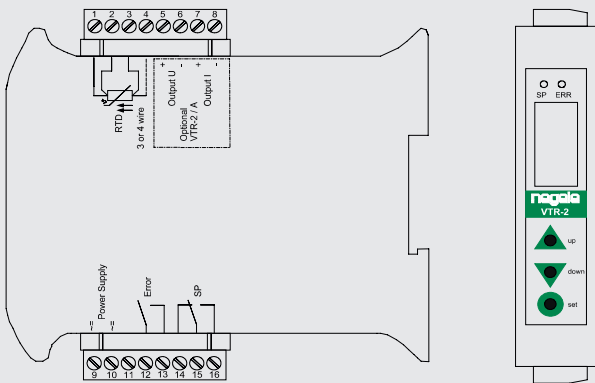

Block diagram

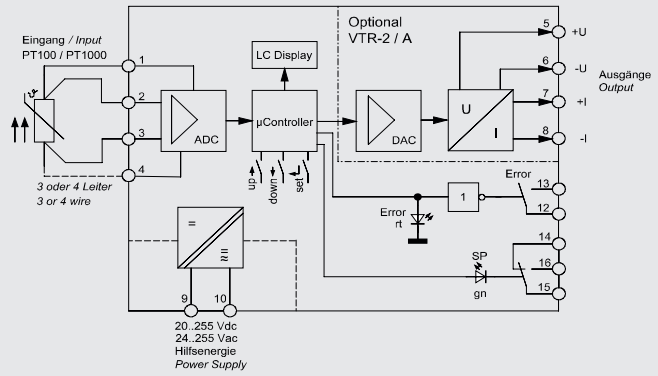

Adjustment

1. Actuate the "set" button for at least 5 s. The text "press set 5 s for setup" appears. The unit then switches to "SET" mode.
2. Use the "up" and "down" buttons to select the desired parameter.
3. Actuate the "set" button. The unit switches into the setup mode for the selected parameter.
4. Use the "up" and "down" buttons to select the desired value.
5. Once the desired value has been set, confirm it using the "set" button. The unit switches back to the main menu.
6. Repeat points 2 to 5 with all other parameters that are to be changed (see menu listing).
7. Select the menu point "Save and Exit" and confirm using the "set" button. The parameters set will be permanently saved. The unit automatically returns to operation mode.

Reference note:



At temperatures above 50 °C the display contrast becomes much worse to the point of illegibility. This has no effect on the function- ing of the unit. The display is not damaged by temperatures within the specified operating temperature range of the unit. The display will return to legibility once the temperature returns to below 50 °C.

Parameter

Name	Function	Adjustment	Factory settings
Value	Switching point, limit value	-200...+850 °C -328...+1562 °F	100 °C
Hyst Delay Logic	Hysteresis Switching delay Direct / inverting switch	1...40 ° 0,1...5 s Direct / Invers	2 ° 0,1 s Direct
Input unit Input RTD type Input measure type	Temperature unit Sensor type Connection type	°C / °F Pt100 / Pt1000 3-wire / 4-wire	°C Pt100 4-wire
Input range min	Input measurement min	-200...+850 °C -328...+1562 °F	0 °C
Input range max	Input measurement max	-200...+850 °C -328...+1562 °F	200 °C
Output	Output type	0...10 V / 0/4...20 mA	0...10 V
Save & Exit	Save and exit		
Cancel	Exit without saving		
Reset	Load factory settings		

Functionality test

1. Connect temperature sensor or simulator at input (KL 1 to 4). In doing so, take heed of the 3-wire or 4-wire connection (in accordance with the software configuration).
2. Connect the auxiliary power supply (KL 9/10).
3. Set unit parameters (e.g. setpoint SP to 100 °C) as described above via the menu.
4. Check the switching function by slowly increasing or decreasing the input signal until the setpoint is reached.
5. Check the required hysteresis and operating delay by altering the input signal.
6. Check the sensor monitoring system by disconnecting the sensor. (Red LED lights and both relays release after approx. 3...4 seconds.)
7. Reconnect the sensor. Briefly actuate one of the buttons. The error message disappears after approx. 3 s.

Advice



Measured values are not recorded nor are switch outputs changed while the module is in "SET" mode. Should no further buttons be actuated within approx. 30 s, the unit returns automatically to operation mode and any alterations made to the parameters up to this point are discarded. The same occurs when the "SET" mode is exited using the menu point "cancel". The unit then operates with the last previously saved values. Exiting the "SET" mode via the menu point "Reset" restores the parameters to their factory default values.

Menu structure listing

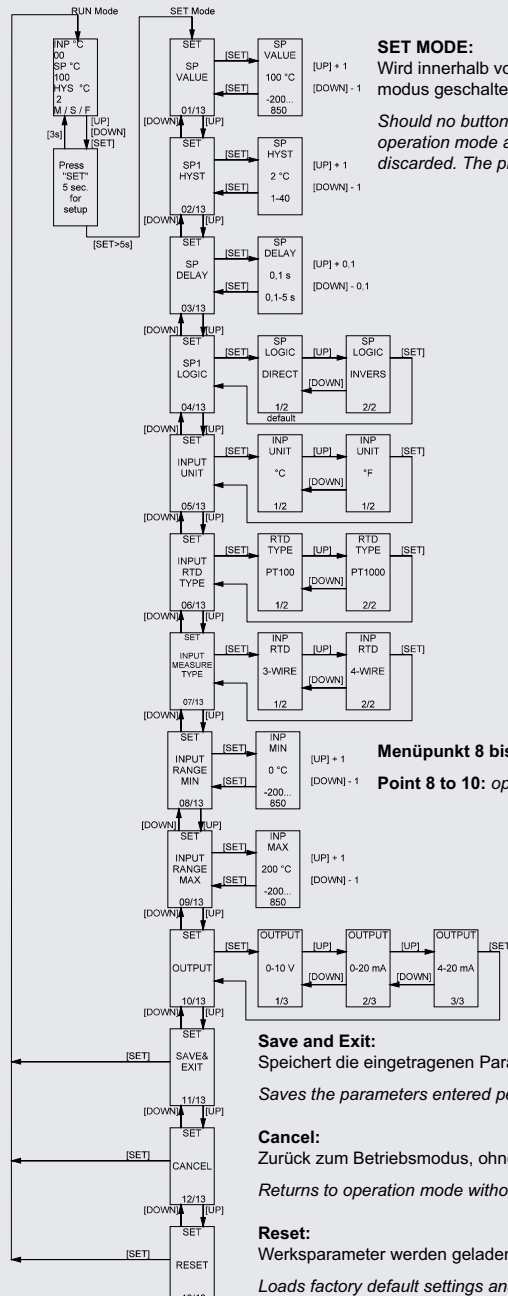

Switching diagram T ≥ 0°

Function maximum limit switch: temperature ≥ 0°

- Logic: "Direct"
- Value: 50 °C
- Hyst: 10 °C

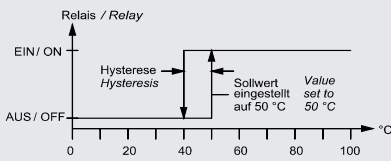

Function minimum limit switch: temperature ≥ 0°

- Logic: "Invers"
- Value: 50 °C
- Hyst: 10 °C

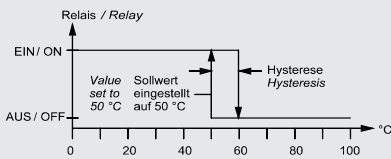

Switching diagram T < 0°

Function maximum limit switch: temperature < 0°

- Logic: "Direct"
- Value: -50 °C
- Hyst: 10 °C

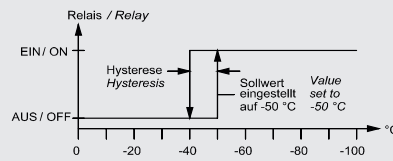

Function minimum limit switch: temperature < 0°

- Logic: "Invers"
- Value: -50 °C
- Hyst: 10 °C

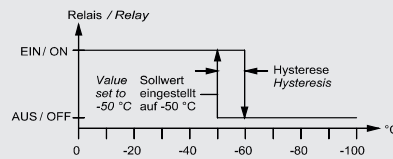

Advice



- For installation and adjustment please pay attention to additional informations given in the data sheet enclosed with the device.

Conventional Usage



- Not suitable for applications in explosive areas.
- Not suitable for applications in security-relevant equipments (SIL).

Standards and Guidelines



- You have to comply with applicable regulations and directives.

Advice to EMC



- The device agrees to following standards: EMC directive 2004/108/EC.
- You have to guarantee the EMC directives for the entire equipment.

Disposal



- This instrument is not subject to the WEEE directive 2002/96/EC and the respective national laws.
- Pass the instrument directly on to a specialised recycling company and do not use the municipal collecting points.

Order Code

VTR-2

Output

- X (change over contact)
- A (analog output 0/4...20 mA or 0...10 V)

Adjustment

- X (standard: measurement range = 0...200, unit = °C, switch point = 100 °C, hysteresis = 2°, switching delay = 0,1 sec)
- special (adjustment acc. to customer preference, please specify in plain text)

VTR-2 / A / X